



Shown in maple, moonstone shearling, and brushed brass

## SQ Upholstered Dining Chair

### DIMENSIONS:

19 D x 17 W x 31.5 H x 19 SH (Inches)

### AVAILABLE MATERIALS:

#### Wood

- ash
- maple
- walnut
- white oak
- ebonized ash
- white washed ash

#### Metal

- brushed brass
- antique brass
- oil rubbed bronze
- brushed nickel

#### Upholstery

COM/COL or in any of our studio selected fabrics and leathers

1 yard fabric or 18 sq ft leather required (depending on pattern and repeat)

# Options

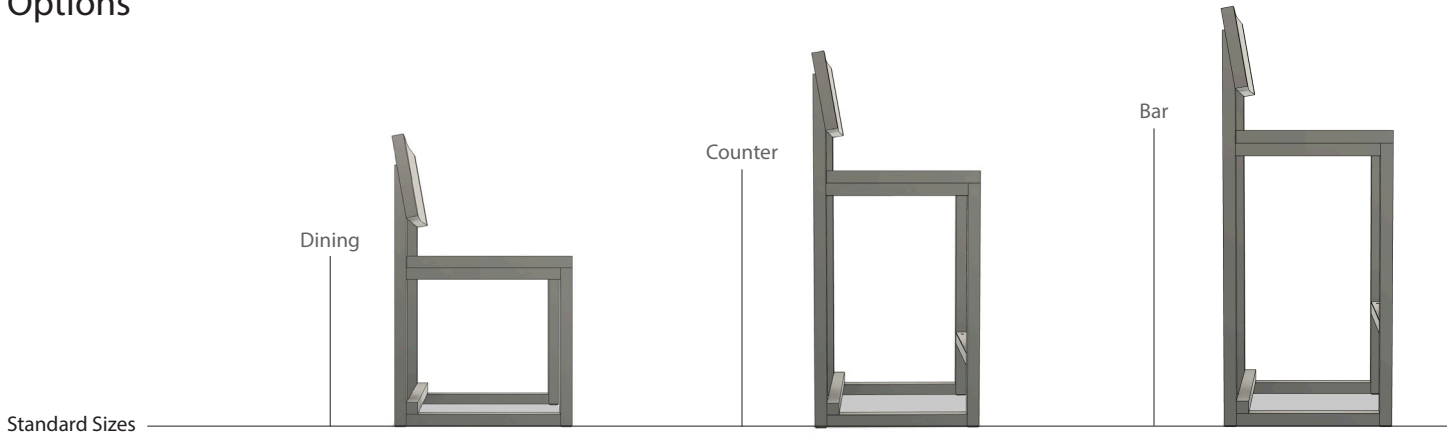

Custom seat height, XL sizing, ADA requirements, and backless versions available upon request.

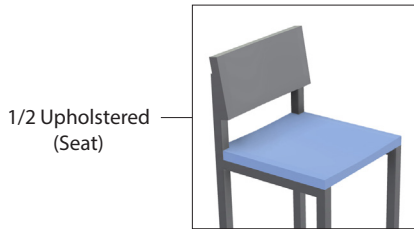
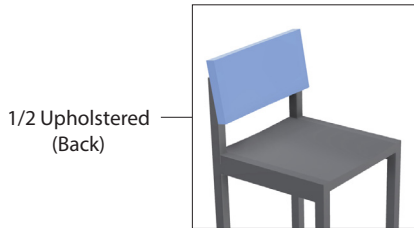
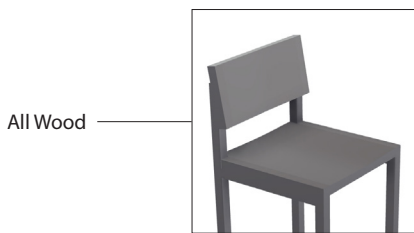

### Material Requirements

	Fabric yards	Leather sq ft
Dining Chair	0.5	9
Counter Stool	0.5	9
Bar Stool	0.5	9

	Fabric yards	Leather sq ft
Dining Chair	0.5	9
Counter Stool	0.5	9
Bar Stool	0.5	9

	Fabric yards	Leather sq ft
Dining Chair	1	18
Counter Stool	0.75	14
Bar Stool	0.75	14

Depending on pattern and repeat – Please confirm selection prior to purchase.

### Metal

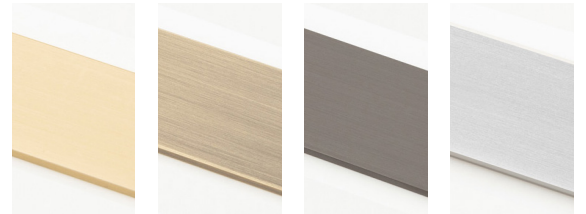

Brushed Brass    Antique Brass    Oil-Rubbed Bronze    Brushed Nickel

### Wood

#### Standard

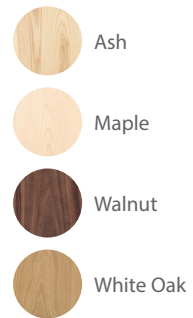

Ash  
Maple  
Walnut  
White Oak

#### Special Edition

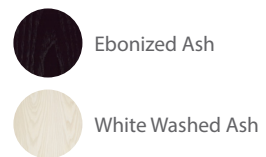

Ebonized Ash  
White Washed Ash