



## SQ Upholstered Counter + Bar Stools

### Counter Height

17 D x 17 W x 37.5 H x 26 SH (Inches)

### Bar Height

17 D x 17 W x 41.5 H x 30 SH (Inches)

### AVAILABLE MATERIALS:

Wood

- ash
- maple
- walnut
- white oak
- ebonized ash
- white washed ash

Metal

- brushed brass
- antique brass
- oil rubbed bronze
- brushed nickel

Upholstery COM/COL or in any of our studio selected fabrics and leathers  
0.75 yards fabric or 14 sq ft leather required (depending on pattern and repeat)



Shown in maple, black leather, and brushed nickel

# Options

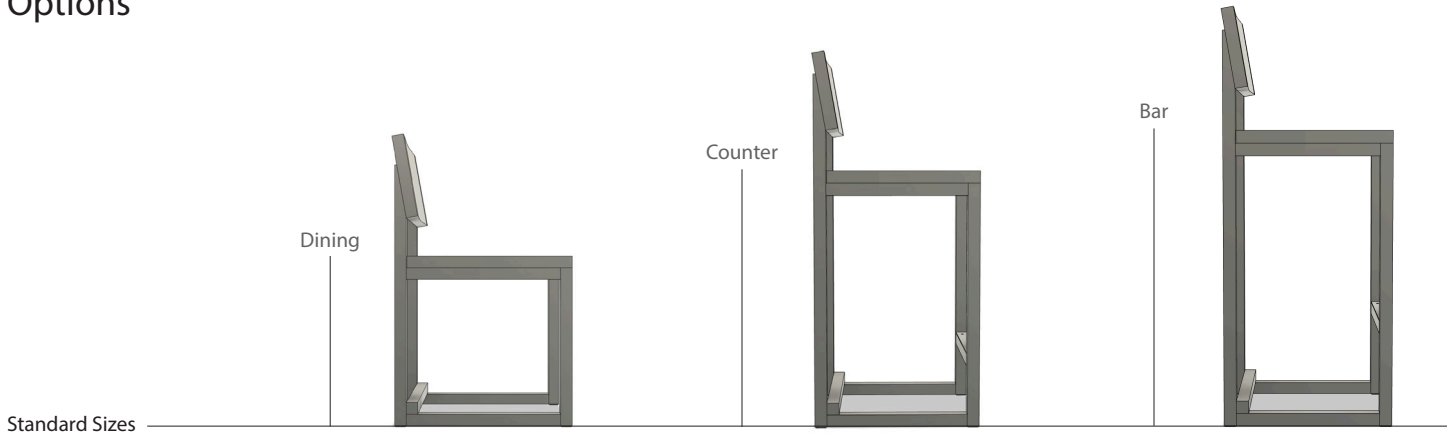

Custom seat height, XL sizing, ADA requirements, and backless versions available upon request.

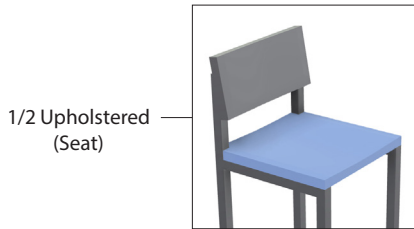
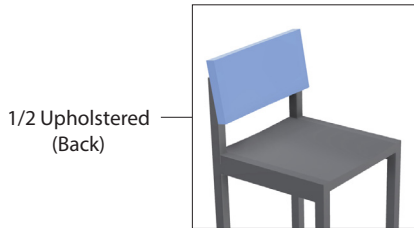
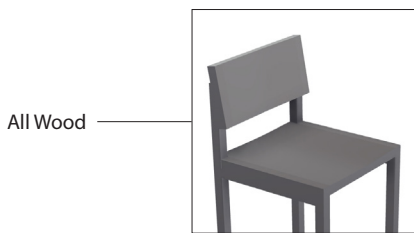

### Material Requirements

	Fabric yards	Leather sq ft
Dining Chair	0.5	9
Counter Stool	0.5	9
Bar Stool	0.5	9

	Fabric yards	Leather sq ft
Dining Chair	0.5	9
Counter Stool	0.5	9
Bar Stool	0.5	9

	Fabric yards	Leather sq ft
Dining Chair	1	18
Counter Stool	0.75	14
Bar Stool	0.75	14

Depending on pattern and repeat – Please confirm selection prior to purchase.



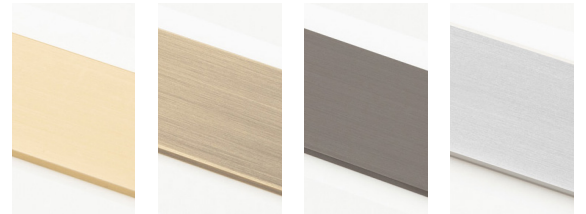



### Metal



Brushed Brass    Antique Brass    Oil-Rubbed Bronze    Brushed Nickel

### Wood

#### Standard

-  Ash
  -  Maple
  -  Walnut
  -  White Oak
- #### Special Edition
-  Ebonized Ash
  -  White Washed Ash