



SQ Upholstered Counter + Bar Stools

Counter Height

17 D x 17 W x 37.5 H x 26 SH (Inches)

Bar Height

17 D x 17 W x 41.5 H x 30 SH (Inches)

AVAILABLE MATERIALS:

Wood

- ash
- maple
- walnut
- white oak
- ebonized ash
- white washed ash

Metal

- brushed brass
- antique brass
- oil rubbed bronze
- brushed nickel

Upholstery COM/COL or in any of our studio selected fabrics and leathers
 0.75 yards fabric or 14 sq ft leather required (depending on pattern and repeat)



Bar stool shown in ash, big sky bouclé, and brushed nickel

Options

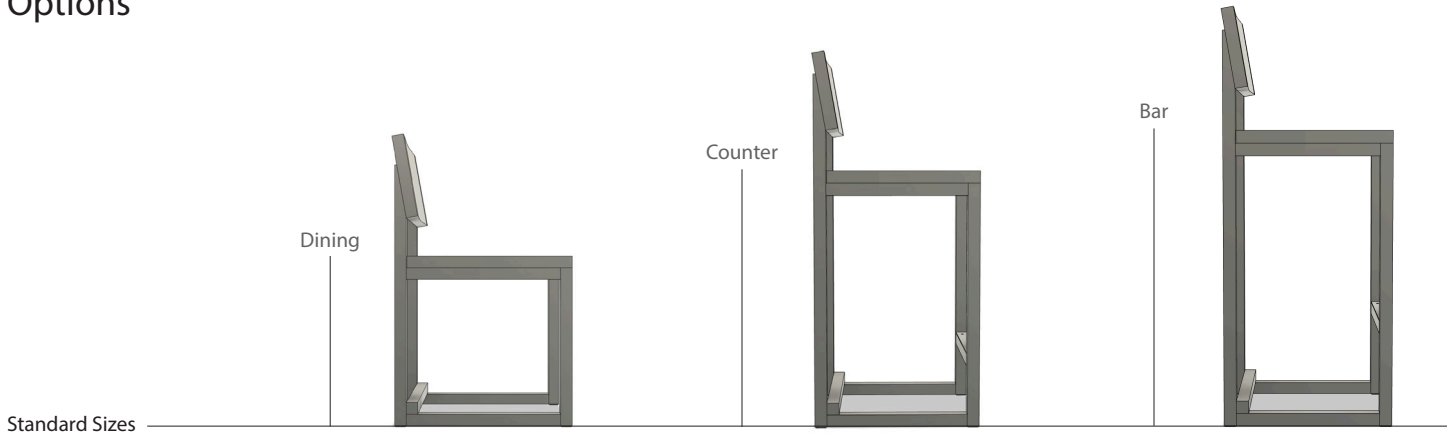

Custom seat height, XL sizing, ADA requirements, and backless versions available upon request.

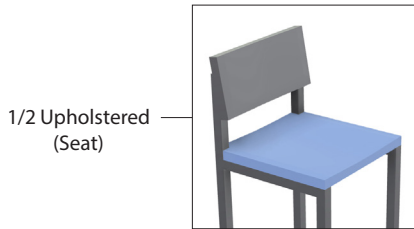
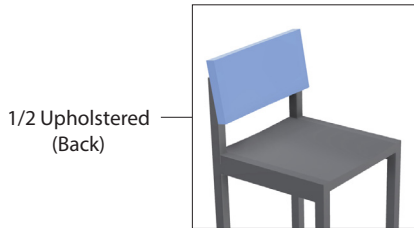
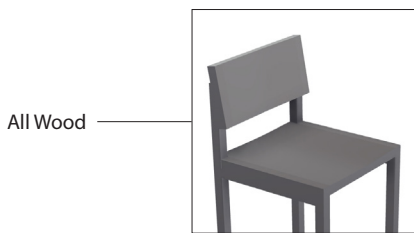

Material Requirements

	Fabric yards	Leather sq ft
Dining Chair	0.5	9
Counter Stool	0.5	9
Bar Stool	0.5	9

	Fabric yards	Leather sq ft
Dining Chair	0.5	9
Counter Stool	0.5	9
Bar Stool	0.5	9

	Fabric yards	Leather sq ft
Dining Chair	1	18
Counter Stool	0.75	14
Bar Stool	0.75	14

Depending on pattern and repeat – Please confirm selection prior to purchase.



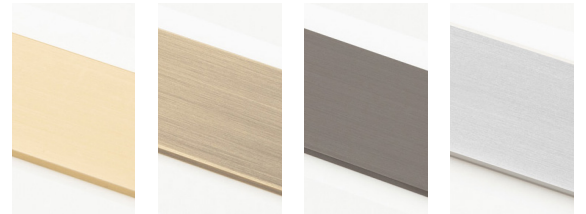

Metal





Brushed Brass Antique Brass Oil-Rubbed Bronze Brushed Nickel

Wood

Standard

-  Ash
-  Maple
-  Walnut
-  White Oak

Special Edition

-  Ebonized Ash
-  White Washed Ash